

# Dell™ SX2210T Flat Panel Monitor User's Guide

[About Your Monitor](#)

[Setting Up the Monitor](#)

[Operating the Monitor](#)

[Troubleshooting](#)

[Appendix](#)

---

## Notes, Notices, and Cautions



**NOTE:** A NOTE indicates important information that helps you make better use of your computer.



**NOTICE:** A NOTICE indicates either potential damage to hardware or loss of data and tells you how to avoid the problem.



**CAUTION:** A CAUTION indicates a potential for property damage, personal injury, or death.

---

Information in this document is subject to change without notice.

© 2009 Dell Inc. All rights reserved.

Reproduction of these materials in any manner whatsoever without the written permission of Dell Inc. is strictly forbidden.

Trademarks used in this text: *DELL* and the *DELL* logo are trademarks of Dell Inc.; *Microsoft*, *Windows*, and *Windows Vista* are either registered trademarks or trademarks of Microsoft Corporation in the United States and/or other countries; *ENERGY STAR* is a registered trademark of the U.S. Environmental Protection Agency. As an ENERGY STAR partner, Dell Inc. has determined that this product meets the ENERGY STAR guidelines for energy efficiency.

Other trademarks and trade names may be used in this document to refer to either the entities claiming the marks and names or their products. Dell Inc. disclaims any proprietary interest in trademarks and trade names other than its own.

---

Model SX2210Tb

August 2009 Rev. A00

[Back to Contents Page](#)

## About Your Monitor

Dell™ SX2210T Flat Panel Monitor User's Guide

- [Package Contents](#)
  - [Product Features](#)
  - [Identifying Parts and Controls](#)
  - [Monitor Specifications](#)
  - [Universal Serial Bus \(USB\) Interface](#)
  - [Plug and Play Capability](#)
  - [Camera - MIC Specifications](#)
  - [Maintenance Guidelines](#)
- 

## Package Contents

Your monitor comes with all the items shown below. Ensure that you have all the items. If something is missing, [contact Dell](#).

 **NOTE:** Some items may be optional and may not ship with your monitor. Some features or media may not be available in certain countries.

|   |                      |
|---|----------------------|
|   | 1 Monitor with stand |
|  | 1 Power cable        |
|  | 1 Power adapter      |
|  | 1 VGA cable          |

|   |  |
|---|--|
|  | <p>1 DVI cable</p>   |
|  | <p>1 USB up stream cable (enables USB ports, Webcam and touch function on the monitor)</p> |
|  | <p>1 Documentation (Safety Information, Quick Start Guide, and CD)</p>                     |
|  | <p>1 Cleaning cloth</p>  |

---

## Product Features

The **SX2210T** flat panel display has an active matrix, thin-film transistor (TFT), liquid crystal display (LCD). The monitor features include:

- 21.5 inches (546.8 mm) diagonal.
  - 1920 X 1080 resolution, plus full-screen support for lower resolutions.
  - Touch sensitive—detects your finger or any other pointing device close to the screen.
  - Tilt adjustment capability.
  - Plug and play capability if supported by your system.
  - On-Screen Display (OSD) adjustments for ease of set-up and screen optimization.
  - Software and documentation media which includes an information file (INF), Image Color Matching File (ICM), Touch Screen Tools software, Webcam Software, Facial Recognition Software, and product documentation.
  - Energy Saver feature for Energy Star compliance.
  - Security lock slot.
  - 2.0 Mega pixel internal webcam with integrated microphone.
- 

## Identifying Parts and Controls

### Front View



Front View

| Label | Description  |
|-------|--|
| 1-2   | Shortcut keys (for more information, see <a href="#">Operating the Monitor</a> ) |
|       | *The default settings are Preset Modes select and Brightness/Contrast select.    |
|       | 1 Preset Modes select  |
|       | 2 Brightness/Contrast select   |
| 3     | OSD menu select  |
| 4     | EXIT   |
| 5     | Power button (with light indicator)  |
| 6     | Webcam   |
| 7     | Microphone   |

### Back View

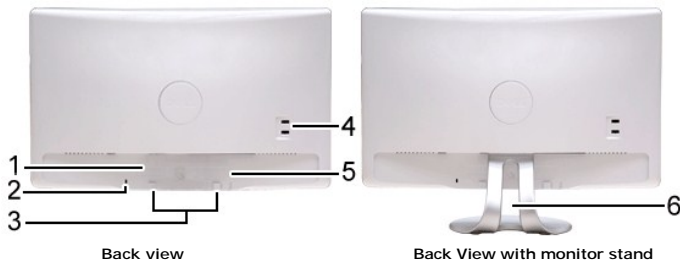

| Label | Description                     | Use  |
|-------|---------------------------------|--|
| 1     | Barcode serial number label     | To contact Dell for technical support.               |
| 2     | Security lock slot              | To help secure your monitor.                         |
| 3     | Dell soundbar mounting brackets | To attach the optional Dell Soundbar.                |
| 4     | USB downstream port             | To connect the USB cable.                            |
| 5     | Regulatory rating label         | Lists the regulatory approvals.                      |
| 6     | Cable management slot           | To organize cables by placing them through the slot. |

### Side View



## Bottom View

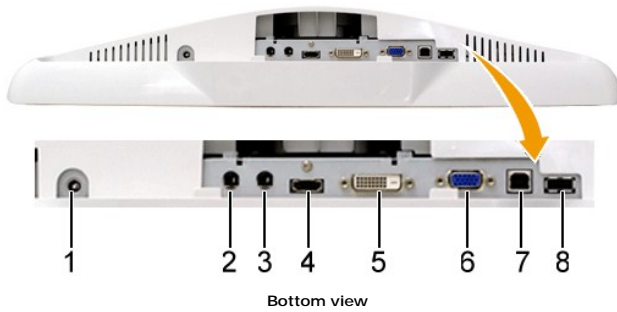

| Label | Description              |
|-------|--------------------------|
| 1     | DC power cord connector  |
| 2     | Audio Line-in            |
| 3     | Audio Line-out           |
| 4     | HDMI connector           |
| 5     | DVI connector            |
| 6     | VGA connector            |
| 7     | USB upstream connector   |
| 8     | USB downstream connector |

## Monitor Specifications

The following sections give you information about the various power management modes and pin assignments for various connectors of your monitor.

### Power Management Modes

If you have VESA's compliance display card or software installed in your PC, the monitor can automatically reduce its power consumption when not in use. This is referred to as *Power Save Mode*. If the computer detects input from keyboard, mouse, or other input devices, the monitor automatically resumes functioning. The following table shows the power consumption and signaling of this automatic power saving feature:

| VESA Modes                      | Horizontal Sync | Vertical Sync | Video   | Power Indicator | Power Consumption |
|---------------------------------|-----------------|---------------|---------|-----------------|-------------------|
| Normal operation and USB active | Active          | Active        | Active  | White           | 42 W (maximum)    |
| Normal operation                | Active          | Active        | Active  | White           | 28 W (typical)    |
| Active-off mode                 | Inactive        | Inactive      | Blanked | Amber           | 0.84 W            |
| Switch off                      | -               | -             | -       | Off             | 0.74 W            |

 **NOTE:** The OSD functions in the 'Normal operation' mode. One of the following messages appears when the menu key is touched in Active-off mode.

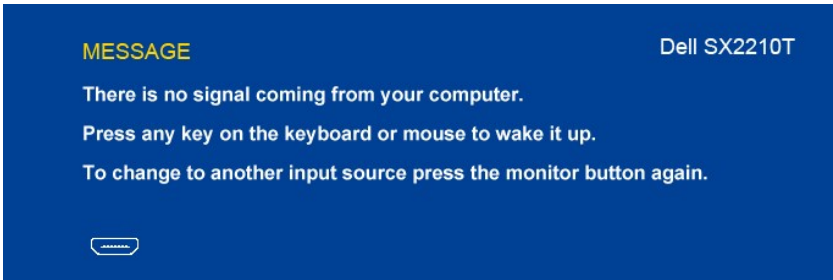
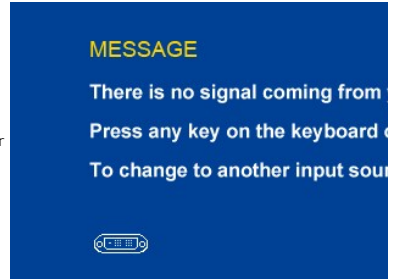
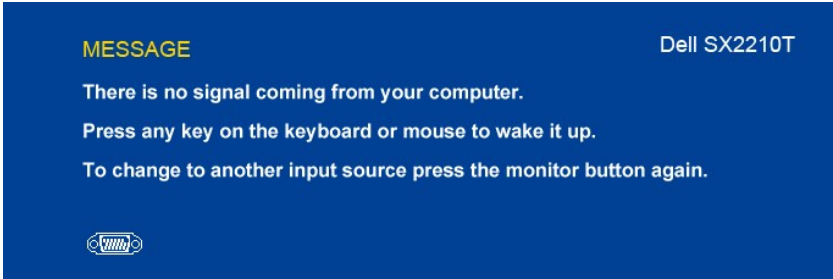

Activate the computer and 'wake up' the monitor to gain access to the [OSD](#).

 **NOTE:** This monitor is ENERGY STAR®-compliant.



Zero power consumption in OFF mode can only be achieved by disconnecting the main cable from the power adapter.

## Pin Assignments

### VGA Connector

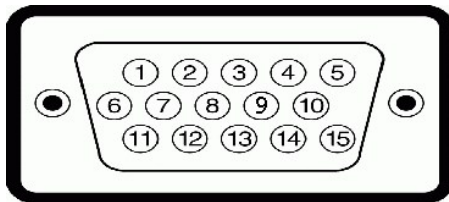

| Pin Number | 15-pin Side of the Connected Signal Cable |
|------------|---|
| 1          | Video-Red                                 |
| 2          | Video-Green                               |
| 3          | Video-Blue                                |
| 4          | GND                                       |
| 5          | Self-test                                 |
| 6          | GND-R                                     |
| 7          | GND-G                                     |
| 8          | GND-B                                     |
| 9          | Computer 5V                               |
| 10         | GND-sync                                  |
| 11         | GND                                       |
| 12         | DDC data                                  |
| 13         | H-sync                                    |
| 14         | V-sync                                    |
| 15         | DDC clock                                 |

### DVI Connector

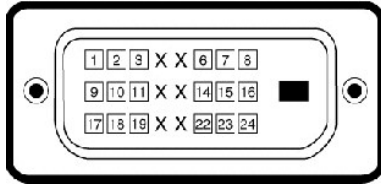

| Pin Number | 24-pin Side of the Connected Signal Cable |
|------------|---|
| 1          | TMDS RX2-                                 |
| 2          | TMDS RX2+                                 |
| 3          | TMDS Ground                               |
| 4          | Floating                                  |
| 5          | Floating                                  |
| 6          | DDC Clock                                 |
| 7          | DDC Data                                  |
| 8          | Floating                                  |
| 9          | TMDS RX1-                                 |
| 10         | TMDS RX1+                                 |
| 11         | TMDS Ground                               |
| 12         | Floating                                  |
| 13         | Floating                                  |
| 14         | +5V power                                 |
| 15         | Self test                                 |
| 16         | Hot Plug Detect                           |
| 17         | TMDS RX0-                                 |
| 18         | TMDS RX0+                                 |
| 19         | TMDS Ground                               |
| 20         | Floating                                  |
| 21         | Floating                                  |
| 22         | TMDS Ground                               |
| 23         | TMDS Clock+                               |
| 24         | TMDS Clock-                               |

### HDMI Connector

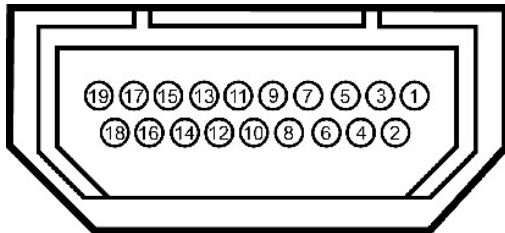

| Pin Number | 19-pin Side of the Connected Signal Cable |
|------------|---|
| 1          | T.M.D.S. Data 2-                          |
| 2          | T.M.D.S. Data 2 Shield                    |
| 3          | T.M.D.S. Data 2+                          |
| 4          | T.M.D.S. Data 1+                          |
| 5          | T.M.D.S. Data 1 Shield                    |
| 6          | T.M.D.S. Data 1-                          |
| 7          | T.M.D.S. Data 0+                          |
| 8          | T.M.D.S. Data 0 Shield                    |
| 9          | T.M.D.S. Data 0-                          |
| 10         | T.M.D.S. Clock +                          |
| 11         | T.M.D.S. Clock Shield                     |
| 12         | T.M.D.S. Clock -                          |

|    |                           |
|----|---------------------------|
| 13 | CEC                       |
| 14 | Reserved (N.C. on device) |
| 15 | SCL                       |
| 16 | SDA                       |
| 17 | DDC/CEC Ground            |
| 18 | +5V Power                 |
| 19 | Hot Plug Detect           |

## Universal Serial Bus (USB) Interface

This section gives you information about the USB ports that are available on the left side of your monitor.

 **NOTE:** This monitor supports High-Speed Certified USB 2.0 interface

| Transfer speed | Data Rate | Power Consumption      |
|----------------|-----------|------------------------|
| High speed     | 480 Mbps  | 2.5W (Max., each port) |
| Full speed     | 12 Mbps   | 2.5W (Max., each port) |
| Low speed      | 1.5 Mbps  | 2.5W (Max., each port) |

### USB Upstream Connector

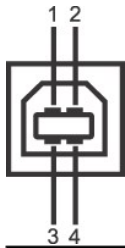

| Pin Number | 4-pin Side of the connector |
|------------|-----------------------------|
| 1          | DMU                         |
| 2          | VCC                         |
| 3          | DPU                         |
| 4          | GND                         |

### USB Downstream Connector

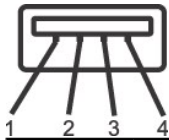

| Pin Number | 4-Pin Side of the Signal Cable |
|------------|--------------------------------|
| 1          | VCC                            |
| 2          | DMD                            |
| 3          | DPD                            |
| 4          | GND                            |

### USB Ports

- 1 1 upstream at bottom
- 1 2 downstream at back & 1 downstream at bottom

 **NOTE:** USB 2.0 functionality requires a USB 2.0-capable computer

 **NOTE:** The monitor's USB interface works only when the monitor is on or in power save mode. If you turn off the monitor and then turn it on, the attached port will resume normal functionality.

## Camera - MIC Specifications

### Overview

The integrated USB camera and analog microphones allow you to take pictures, videos, and communicate with other computer users. The camera is located at the top of the monitor and is fixed. When the camera is on, the white light next to the camera turns on.



|                     |                                 |  |
|---------------------|---------------------------------|--|
| Lens                | Field of view                   | 66.2 degree +/- 5 %                                    |
|                     | Focus mode                      | Fixed Focus  |
|                     | Focus area                      | 37 cm-Infinity   |
|                     | Focusing distance (normal mode) | 1.100 mm   |
| Image Sensor        | Active array size               | 2.0 mega-pixel   |
| Video specification | Video frame rate                | 1600 x 1200 (UXGA) - up to 10 frames per second        |
|                     |                                 | 640 x 480 (VGA) and below - up to 30 frames per second |
|                     | Image flip                      | Horizontally   |
| Audio Specification | Microphone type                 | Dual Microphone  |
| Interface           |                                 | USB 2.0 high Speed                                     |

## System Requirements

The following are the minimum system requirements for the Dell Webcam Software Suite:

- 1 Intel® Pentium® D 3.0 or AMD® Athlon 64 3200+ or higher
- 1 Microsoft® Windows® XP Service Pack 2 or Windows Vista® or Windows 7
- 1 512 MB RAM (1 GB RAM or higher recommended)
- 1 1 GB free hard disk space
- 1 Graphic card Intel 945 at least (Independent graphics card recommended)
- 1 Available USB 2.0 port or a USB 2.0 hub with external power supply

### Dell Webcam Software Suite

The Dell Webcam Software Suite includes the following applications:

#### Dell TouchCam

Dell TouchCam enables convenient access to all exciting applications to enhance your Dell webcam experience. See [Using the Camera](#) for details

#### Facial Recognition Software (FastAccess)

Face recognition technology greatly reduces the need to manually log in with passwords, while providing superior security and functionality compared to passwords and other biometrics (for Windows Vista® or Windows 7 only). See [Installing and Using the Facial Recognition Software \(FastAccess\)](#) for details.

## Plug and Play Capability

You can install the monitor in any Plug and Play-compatible system. The monitor automatically provides the computer system with its Extended Display Identification Data (EDID) using Display Data Channel (DDC) protocols so the system can configure itself and optimize the monitor settings. Most monitor installations are automatic; you can select different settings if desired. For more information about changing the monitor settings, see [Operating the Monitor](#).

## Flat Panel Specifications

|                        |   |
|------------------------|---|
| Screen type            | Active matrix - TFT LCD   |
| Panel Type             | TN  |
| Screen dimensions      | 21.5 inches (21.5-inch measured diagonally viewable image size) |
| Preset display area:   |   |
| Horizontal:            | 476.64 mm (18.76 inches)  |
| Vertical:              | 268.11 mm (10.56 inches)  |
| Pixel pitch            | 0.248 mm  |
| Viewing angle          | 160° (vertical) typical, 160° (horizontal) typical              |
| Luminance output       | 220 CD/m <sup>2</sup> (typical)                                 |
| Contrast ratio         | 1000:1 (typical)  |
| Dynamic contrast ratio | 50,000:1 (max)  |
| Faceplate coating      | Anti-glare with hard-coating (3H)                               |
| Backlight              | CCFL edgelight system   |
| Response Time          | 2 ms typical (Grey to Grey)                                     |
| Color Depth            | 16.7 mil colors   |
| Color Gamut            | 83%*  |

\* SX2210T color gamut (typical) is based on CIE1976 (83%) and CIE1931 (72%) test standards.

---

## Touch Screen Specifications

|                        |  |
|------------------------|--|
| Touch Technology       | Optical touch  |
| Touch Method           | Finger, stylus or any pointer.                                       |
| Stylus Diameter        | Minimum 7 mm   |
| Capabilities           | Mouse functionality—click, drag, double-click and right-click        |
| Resolution             | 1073 Mpixel  |
| Accuracy               | +/-2.5 mm over 95% of touchable area (Microsoft Windows 7 compliant) |
| Touch Activation Force | No pressure required   |
| Touch Durability       | Unlimited  |
| Touch Response Time    | Typical response time 15 ms  |
| Glass                  | 2.5 mm chemically toughened glass                                    |

---

## Resolution Specifications

|                           |                              |
|---------------------------|------------------------------|
| Horizontal scan range     | 30 kHz to 83 kHz (automatic) |
| Vertical scan range       | 50 Hz to 76 Hz (automatic)   |
| Optimal preset resolution | 1920 x 1080 at 60 Hz         |
| Highest preset resolution | 1920 x 1080 at 60 Hz         |

## Video Supported Modes

|   |  |
|---|--|
| Video display capabilities (DVI playback) | 480i/480p/576i/576p/720p/1080i/1080p (Supports HDCP) |
|---|--|

---

## Preset Display Modes

| Display Mode  | Horizontal Frequency (kHz) | Vertical Frequency (Hz) | Pixel Clock (MHz) | Sync Polarity (Horizontal/Vertical) |
|---------------|----------------------------|-------------------------|-------------------|-------------------------------------|
| 640 x 350     | 31.47                      | 70.09                   | 25.18             | +/-                                 |
| 640 x 400     | 31.47                      | 70.09                   | 25.18             | -/+                                 |
| 640 x 480     | 31.47                      | 59.94                   | 25.17             | -/-                                 |
| 640 x 480     | 31.50                      | 75.00                   | 31.5              | -/-                                 |
| 720 x 400     | 31.47                      | 70.08                   | 28.32             | -/+                                 |
| 800 x 600     | 37.88                      | 60.32                   | 40.00             | +/+                                 |
| 800 x 600     | 46.880                     | 75.00                   | 49.50             | +/+                                 |
| 1024 x 768    | 48.36                      | 60.00                   | 65.00             | -/-                                 |
| 1024 x 768    | 60.02                      | 75.03                   | 78.75             | +/+                                 |
| 1152 x 864    | 67.50                      | 75.00                   | 108.00            | +/+                                 |
| 1280 x 1024   | 63.98                      | 60.02                   | 108.00            | +/+                                 |
| 1280 x 1024   | 79.98                      | 75.02                   | 135.00            | +/+                                 |
| 1920 x 1080-R | 66.587                     | 59.934                  | 138.50            | +/-                                 |
| 1920 x 1080   | 55.62                      | 49.92                   | 141.50            | -/+                                 |

---

## Electrical Specifications

|   |   |
|---|---|
| Video input signals                           | Analog RGB, 0.7 Volts +/- 5%, positive polarity at 75 ohm input impedance<br>Digital DVI-D TMDS, HDMI, 600mV for each differential line, positive polarity at 50 ohm input impedance    |
| Audio Input and Output signals                | Input signal level: 1Vrms without chipping  |
| Synchronization input signals                 | Separate horizontal and vertical synchronizations, polarity-free TTL level, SOG (Composite SYNC on green)   |
| AC/DC Adaptor input voltage/frequency/current | 100 to 240 VAC/50 or 60 Hz $\pm$ 3 Hz/1.6A (Max.)<br> For use only with power supply DELL, DA65NS4-00. |
| Inrush current                                | 120 V: 30 A (Max.)<br>240 V: 60 A (Max.)  |

## Physical Characteristics

|                                       |  |
|---------------------------------------|--|
| Connector type                        | 15-pin D-sub miniature, blue connector; DVI-D, white connector; HDMI, Black connector  |
| Signal cable type                     | Digital: Detachable, DVI-D, Solid pins, shipped detached from the monitor<br>Analog: Detachable, D-Sub, 15pins, shipped attached to the monitor<br>HDMI: Detachable, HDMI-A, Solid pins, shipped without cable |
| <b>Dimensions (with stand)</b>        |  |
| Height                                | 401.8 mm (15.82 inches)  |
| Width                                 | 551.5 mm (21.71 inches)  |
| Depth                                 | 194.3 mm (7.61 inches)   |
| <b>Dimensions (without stand)</b>     |  |
| Height                                | 342.1 mm (13.47 inches)  |
| Width                                 | 551.5 mm (21.71 inches)  |
| Depth                                 | 92.3 mm (3.63 inches)  |
| <b>Stand dimensions</b>               |  |
| Height                                | 257.5 mm (10.14 inches)  |
| Width                                 | 228.7 mm (9.00 inches)   |
| Depth                                 | 193.4 mm (7.61 inches)   |
| <b>Weight</b>                         |  |
| Weight with packaging                 | 9.11 kg (20.04 lbs)  |
| Weight with stand assembly and cables | 7.68 kg (16.90 lbs)  |
| Weight without cable assembly         | 6.98 kg (15.36 lbs)  |
| Weight of stand assembly              | 1.93 kg (4.25 lbs)   |

## Environmental Characteristics

|                    |   |
|--------------------|---|
| <b>Temperature</b> |   |
| Operating          | 0° to 40° C (32° to 104°F)  |
| Non-operating      | Storage: -20° to 60° C (-4° to 140° F)<br>Shipping: -20° to 60° C (-4° to 140° F) |
| <b>Humidity</b>    |   |
| Operating          | 10% to 80% (non-condensing)   |

|                            |   |
|----------------------------|---|
| Non-operating              | Storage: 20% to 80% (non-condensing)<br>Shipping: 20% to 80% (non-condensing) |
| <b>Altitude</b>            |   |
| Operating                  | 3,657.60 m (12,000 ft) max  |
| Non-operating              | 12,192 m (40,000 ft) max  |
| <b>Thermal dissipation</b> | 222.3 BTU/hour (maximum)<br>188.1 BTU/hour (typical)                          |

---

## Maintenance Guidelines

### Cleaning Your Monitor

-  **CAUTION:** Read and follow the [safety instructions](#) before cleaning the monitor.
-  **CAUTION:** Before cleaning the monitor, unplug the monitor power cable from the electrical outlet.

For best practices, follow the instructions in the list below while unpacking, cleaning, or handling your monitor:

- 1 To clean your touch screen, use the supplied soft, clean cloth. Do not use benzene, thinner, ammonia, abrasive cleaners, or compressed air. Avoid wiping the top corners of the monitor where the optics are located.
  - 1 Use a lightly-dampened, warm cloth to clean the monitor. Avoid using detergent of any kind as some detergents leave a milky film on the monitor.
  - 1 Handle your monitor with care; any scratch on the monitor will show scuff marks.
  - 1 To help maintain the best image quality on your monitor, use a dynamically changing screen saver and turn off your monitor when not in use.
- 

[Back to Contents Page](#)

[Back to Contents Page](#)

## Appendix

Dell™ SX2210T Flat Panel Monitor User's Guide

- [Safety Instructions](#)
- [FCC Notice \(U.S. Only\) and Other Regulatory Information](#)
- [Contacting Dell](#)

---

### CAUTION: Safety Instructions

 CAUTION: Use of controls, adjustments, or procedures other than those specified in this documentation may result in exposure to shock, electrical hazards, and/or mechanical hazards.

For information on safety instructions, see the safety information that shipped with your monitor.

---

### FCC Notices (U.S. Only) and Other Regulatory Information

For FCC notices and other regulatory information, see the regulatory compliance website located at [www.dell.com/regulatory\\_compliance](http://www.dell.com/regulatory_compliance).

---

### Contacting Dell

For customers in the United States, call 800-WWW-DELL (800-999-3355).

 **NOTE:** If you do not have an active Internet connection, you can find contact information on your purchase invoice, packing slip, bill, or Dell product catalog.

Dell provides several online and telephone-based support and service options. Availability varies by country and product, and some services may not be available in your area. To contact Dell for sales, technical support, or customer service issues:

1. Visit [support.dell.com](http://support.dell.com).
2. Verify your country or region in the **Choose A Country/Region** drop-down menu at the bottom of the page.
3. Click **Contact Us** on the left side of the page.
4. Select the appropriate service or support link based on your need.
5. Choose the method of contacting Dell that is convenient for you.

---

[Back to Contents Page](#)

[Back to Contents Page](#)

## Setting Up Your Monitor

### Dell™ SX2210T Flat Panel Monitor

---

#### **If you have a Dell™ desktop or a Dell™ portable computer with internet access**

1. Go to <http://support.dell.com>, enter your service tag, and download the latest driver for your graphics card.
2. After installing the drivers for your graphics Adapter, attempt to set the resolution to **1920 X 1080** again.

 **NOTE:** If you are unable to set the resolution to 1920 x 1080, please contact Dell™ to inquire about a graphics Adapter that supports these resolutions.

---

[Back to Contents Page](#)

[Back to Contents Page](#)

## Setting Up Your Monitor

Dell™ SX2210T Flat Panel Monitor

---

### If you have a non Dell™ desktop, portable computer, or graphics card

1. Right-click on the desktop and click **Properties**.
2. Select the **Settings** tab.
3. Select **Advanced**.
4. Identify your graphics controller supplier from the description at the top of the window (e.g. NVIDIA, ATI, Intel etc.).
5. Refer to the graphic card provider website for updated driver (for example, <http://www.ATI.com> OR <http://www.NVIDIA.com>).
6. After installing the drivers for your graphics adapter, attempt to set the resolution to **1920 X 1080** again.

 **NOTE:** If you are unable to set the resolution to 1920 x 1080, please contact the manufacturer of your computer or consider purchasing a graphics adapter that will support the video resolution of 1920 x 1080.

---

[Back to Contents Page](#)

[Back to Contents Page](#)

## Operating the Monitor

Dell™ SX2210T Flat Panel Monitor User's Guide

- [Turn On the Monitor](#)
- [Using the Front Panel Controls](#)
- [Using the On-Screen Display \(OSD\) Menu](#)
- [Setting the Maximum Resolution](#)
- [Using the Dell Soundbar \(Optional\)](#)
- [Using the Tilt](#)
- [Using the Camera](#)
- [Installing and Using the Facial Recognition Software \(FastAccess\)](#)
- [Using the Touch Screen](#)

---

### Turn On the Monitor

Press the  button to turn on the monitor





---

### Using the Front Panel Controls

Use the buttons on the front of the monitor to adjust the image settings.



|   | Front panel button   | Description   |
|---|--|---|
| A | <br>Preset modes          | Use the Preset modes button to choose from a list of preset color modes. See <a href="#">Using the OSD Menu</a> . |
| B | <br>Brightness / Contrast | Use the Brightness / Contrast button to direct access to the "Brightness" and "Contrast" control menu.            |
| C | <br>Menu                  | Use the Menu button to open the on-screen display OSD).   |
| D |  |   |





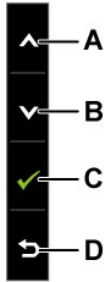

|   |  |
|---|--|
| <br>Exit | Use the Exit button to exit on-screen display (OSD) from menu and sub-menus. |
|---|--|

## Front panel button

Use the [buttons](#) on the side of the monitor to adjust the image settings.



| Front panel Button |   | Description  |
|--------------------|---|--|
| A                  | <br>Up     | Use the Up button to adjust (increase ranges) items in the OSD menu.   |
| B                  | <br>Down   | Use the Down button to adjust (decrease ranges) items in the OSD menu. |
| C                  | <br>OK   | Use the OK button to confirm your selection.                           |
| D                  | <br>Back | Use the back button to go back to the main menu.                       |

## Using the On-Screen Display (OSD) Menu

### Accessing the Menu System

 **NOTE:** If you change the settings and then either proceed to another menu or exit the OSD menu, the monitor automatically saves the changes. The changes are also saved if you change the settings and then wait for the OSD menu to disappear.

1. Press any key to launch the OSD menu and press  to display the main menu.  
**Main Menu**

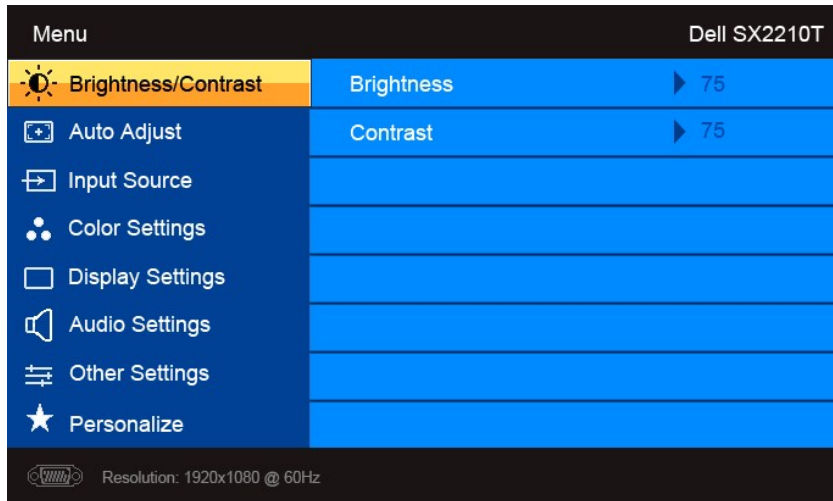

2. Press the and buttons to toggle between options in the Menu. As you move from one icon to another, the option name is highlighted.
3. To select the highlighted item on the menu press the again.
4. Press the and buttons to select the desired parameter.
5. Press the buttons to enter the slide bar and then use the or button, according to the indicators on the menu, to make your changes.
6. Select the to return to previous menu without accepting current settings or to accept and return to previous menu.

The table below provides a list of all the OSD menu options and their functions.

| Icon | Menu and Submenus          | Description   |
|------|----------------------------|---|
|      | <b>BRIGHTNESS/CONTRAST</b> | Use the Brightness and Contrast menu to adjust the Brightness/Contrast.   |
|      |                            |   |
|      | Back                       | Press the  button to go back to the main menu.  |
|      | Brightness                 | Allows you to adjust the brightness or luminance of the backlight.<br>Press the  button to increase brightness and press the  button to decrease brightness (min 0 ~ max 100).  |
|      | Contrast                   | Allows you to adjust the contrast or the degree of difference between darkness and lightness on the monitor screen. Adjust brightness first, and adjust contrast only if you need further adjustment.<br>Press the  button to increase contrast and press the  button to decrease contrast (min 0 ~ max 100). |
|      | <b>Auto Adjust</b>         | Use this button to activate automatic setup and adjust menu. The following dialog appears on a black screen as the monitor adjusts to the current input:  |

Auto Adjustment in Progress...

Auto Adjustment allows the monitor to self-adjust to the incoming video signal. After using Auto Adjustment, you can fine-tune your monitor by using the Pixel Clock (Coarse) and Phase (Fine) controls under Image Settings.

**NOTE:** Auto Adjust does not occur if you press the button while there are no active video input signals or attached cables.



### Input Source

Use the Input Source menu to select different video signals that may be connected to your monitor.

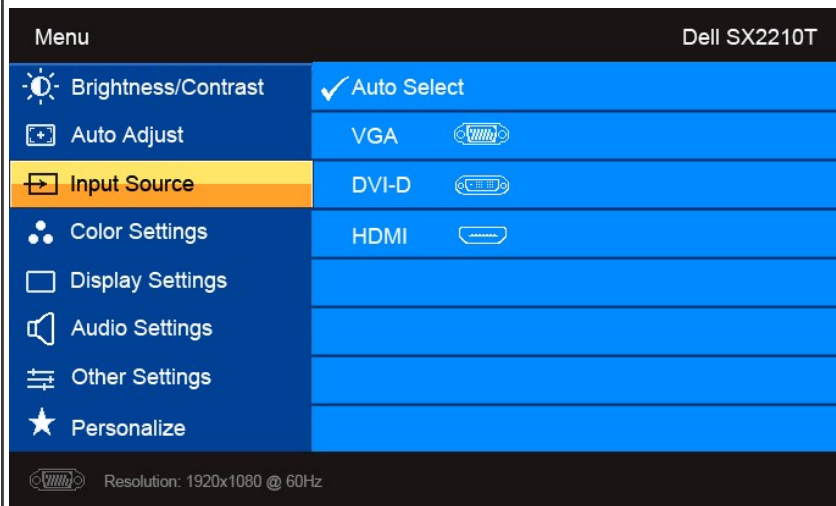

Press the  button to go back to the main menu

Select VGA input when you are using the analog (VGA) connector. Press the  button to select the VGA input source.

Select DVI-D input when you are using the digital (DVI) connector. Press the  button to select the DVI input source.

Select HDMI input when you are using the digital (HDMI) connector. Press the  button to select the HDMI input source.

Select Auto select to let the monitor search for available input signals.









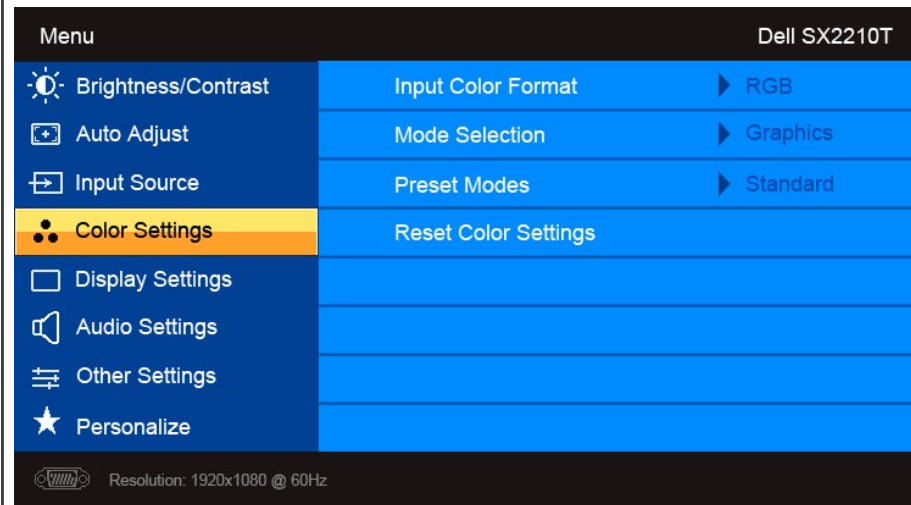

### COLOR SETTINGS

Color setting mode submenu

Use the **Color Setting** menu to adjust the monitor's color settings.

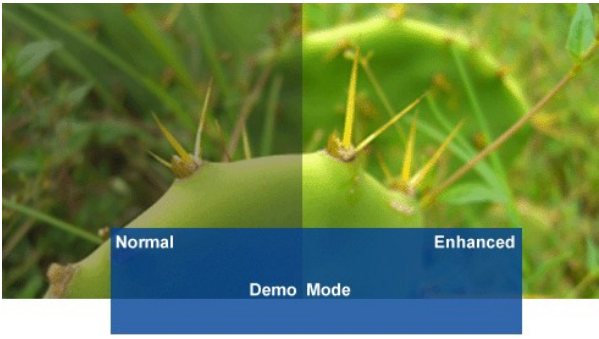

|   |  |  |
|---|--|--|
|   | <p><b>Back</b></p> <p><b>Input Color Format</b></p> <p><b>Mode Selection</b></p> <p><b>Preset Mode</b></p> <p><b>Hue</b></p> <p><b>Saturation</b></p> <p><b>Demo Mode</b></p> <p><b>Reset Color Settings</b></p> | <p>Press the  button to go back to the main menu.</p> <p>Allows you to set the video input mode to:</p> <ul style="list-style-type: none"> <li>1 <b>RGB</b>: Select this option if your monitor is connected to a computer or DVD player using the HDMI cable or the HDMI adapter.</li> <li>1 <b>YPbPr</b>: Select this option if your DVD player supports only YPbPr output.</li> </ul> <p>Allows you to set the display mode to:</p> <ul style="list-style-type: none"> <li>1 <b>Graphics</b>: Select this mode if your monitor is connected to your computer.</li> <li>1 <b>Video</b>: Select this mode if your monitor is connected to a DVD player.</li> </ul> <p><b>NOTE</b>: Depending upon the Display Mode, select the Preset Modes available for your monitor change.</p> <p>Allows you to choose from a list of preset color modes.<br/>In the <b>Graphics</b> mode, you can set the color to the following preset values:</p> <ul style="list-style-type: none"> <li>1 <b>Standard</b>: Loads the monitor's default color settings. This is the default preset mode.</li> <li>1 <b>Multimedia</b>: Loads color settings ideal for multimedia applications.</li> <li>1 <b>Game</b>: Loads color settings ideal for most gaming applications.</li> <li>1 <b>Warm</b>: Increase the color temperature. The screen appears warmer with a red/yellow tint.</li> <li>1 <b>Cool</b>: Decreases the color temperature. The screen appears cooler with a blue tint.</li> <li>1 <b>Custom (RGB)</b>: Allows you to manually adjust the color settings. Press the  and  buttons to adjust the Red and Blue values and create your own preset color mode.</li> </ul> <p>In the <b>Video</b> mode, you can set the color to the following preset values:</p> <ul style="list-style-type: none"> <li>1 <b>Movie</b>: Loads color settings ideal for movies. This is the default preset mode.</li> <li>1 <b>Game</b>: Loads color settings ideal for most gaming applications.</li> <li>1 <b>Sports</b>: Loads color settings ideal for sports.</li> <li>1 <b>Nature</b>: Loads color settings ideal for nature.</li> </ul> <p>Allows you to adjust the skin tone of the image. Use  or  button to adjust the hue from '0' to '100'.</p> <p><b>NOTE</b>: Hue adjustment is available only in the <b>Video</b> mode.</p> <p>Allows you to adjust the color saturation of the image. Use  or  button to adjust the saturation from '0' to '100'.</p> <p><b>NOTE</b>: Saturation adjustment is available only in the <b>Video</b> mode.</p> <p>Vertically splits the screen into two segments. The left half of the screen in the normal mode and the right half of the screen displayed in the color enhanced mode.</p>  <p><b>NOTE</b>: Demo Mode is only available for video input.</p> <p>Resets your monitor's color settings to the factory defaults.</p> |
|  | <p><b>DISPLAY SETTINGS</b></p>   |  |

Display setting mode submenu

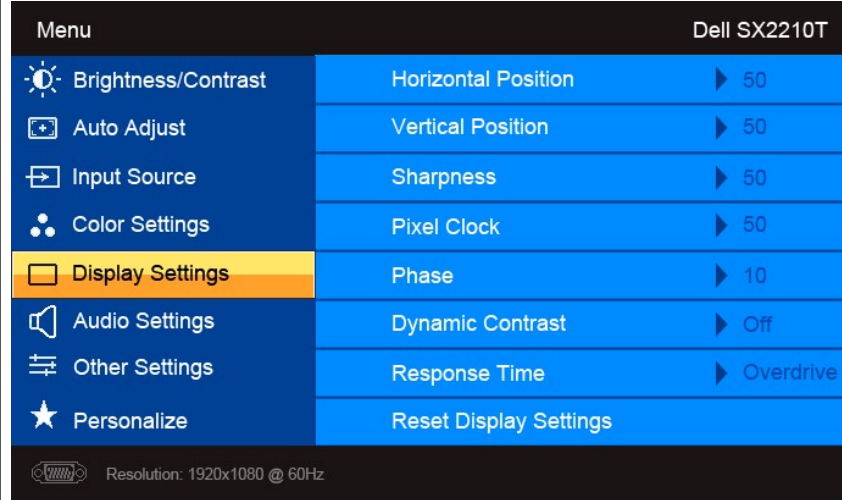

Back

Press the button to go back to the main menu.

Horizontal position

Use the and buttons to adjust image left and right (min 0 ~ max 100).  
**NOTE:** When using DVI or HDMI source, the Horizontal Position setting is not available.

Vertical Position

Use the and buttons to adjust image up and down (min 0 ~ max 100).  
**NOTE:** When using DVI or HDMI source, the Vertical Position setting is not available.

Pixel Clock

The Phase and Pixel Clock adjustments allow you to adjust your monitor to your preference. These settings are access main OSD menu, by selecting 'Display Settings'.  
 Use the and buttons to adjust for best image quality.

Phase

If satisfactory results are not obtained using the phase adjustment, use the Pixel Clock (coarse) adjustment and then (fine).  
**NOTE:** Pixel Clock and Phase Adjustments are only available for "VGA" input.

Sharpness

Allows you to increase or decrease the sharpness of the image.  
 Use and buttons to adjust the sharpness from '0' to '100'.

Dynamic Contrast

The dynamic contrast helps get a higher contrast if you choose Game preset, Movie preset, Sports preset and Nature p  
 Use the button to enable the Dynamic Contrast adjustment.  
 Use the button to disable the Dynamic Contrast adjustment.  
**NOTE:** Brightness control is disabled in Dynamic Contrast mode.

Response Time

Response time is the time required for an LCD pixel to change from fully active (black) to fully inactive (white), then back again.  
 You can set the response time to:

- 1 Normal
- 1 Overdrive (default).

Reset Display Settings

Resets the monitor's display settings to the factory defaults.



AUDIO SETTINGS

Use the **Audio Settings** menu to adjust the audio settings.

Audio Setting mode submenu



Line Out Source

Select the source of the audio input.

Power Save Audio

Allows you to turn on or off the power to the audio during the audio power save mode. Default is "On".

**On** – Allows you to turn off the line-out to the sound bar during monitor standby.  
**Off** – Allows you to turn on the line-out to the sound bar during monitor standby.

Reset Audio Setting

Resets your monitor audio settings to the factory defaults.

Exit Menu

Press the button to exit the OSD main menu and Press the button to accept changes.



OTHER SETTINGS

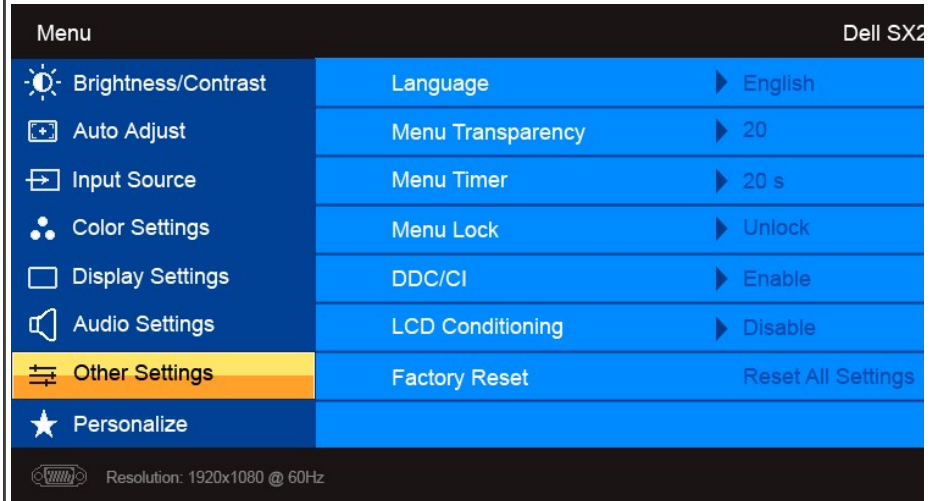

Back

Press the button to go back to the main menu.

Language

Allows you to set the OSD display to one of six languages: English, Espanol, Francais, Deutsch, Simplified Chinese or Japanese.

Menu Transparency

Allows you to adjust the OSD background from opaque to transparent.

Menu Timer

Allows you to set the time for which the OSD remains active after you press a button on the monitor. Use the and buttons to adjust the slider in 1 second increments, from 5 to 60 seconds.

Menu Lock

Controls user access to adjustments. When **Lock** is selected, no user adjustments are allowed. All buttons are locked. Press the button to unlock.

**NOTE:** When the OSD is locked, pressing the button takes you directly to the OSD settings menu, with 'OSD Lock' on entry. Choose "Unlock" and allow user access to all applicable settings.

**DDC/CI**

DDC/CI (Display Data Channel/Command Interface) allows a software on your computer to adjust the monitor display settings such as the brightness, color balance etc.

**Enable** (Default): Optimizes the performance of your monitor and provides a better customer experience.

**Disable**: Disables the DDC/CI option and the following message appears on the screen.

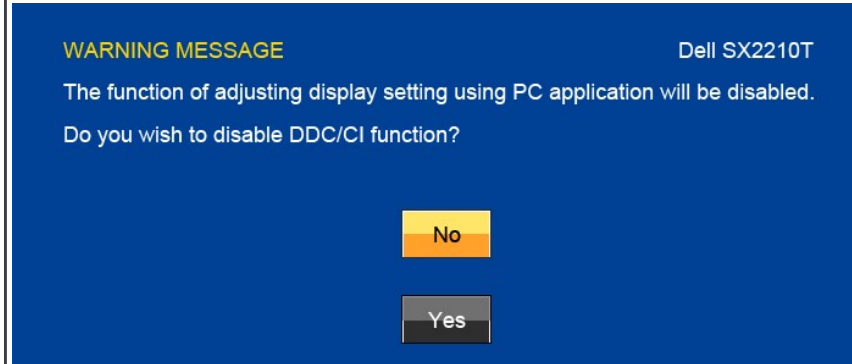

Select **Yes** to disable DDC/CI or **No** to return.

**LCD Conditioning**

LCD conditioning helps eliminate any image retention and may take several hours.

**NOTE**: Severe cases of image retention are known as burn-in. LCD Conditioning does not remove burn-in.

**Disable**: This is the default option.

**Enable**: Enables LCD conditioning and the following message appears on the screen. Select **Yes** to proceed and **No** to return.

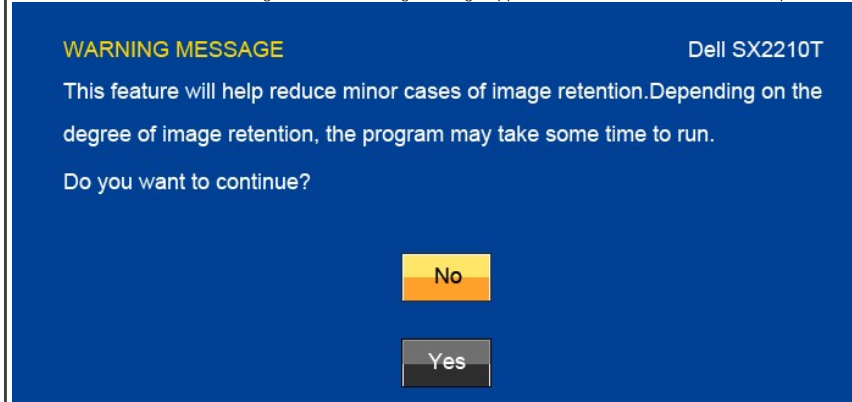

**NOTE**: Press any button on the monitor to terminate LCD Conditioning at any time.



**Factory Reset**

Resets all OSD settings to the factory preset values.



Personalize

Menu
Dell SX2210T

|                        |               |                       |
|------------------------|---------------|-----------------------|
| ☀️ Brightness/Contrast | Shortcut Key1 | ▶ Preset Modes        |
| 📺 Auto Adjust          | Shortcut Key2 | ▶ Brightness/Contrast |
| 📡 Input Source         |               |                       |
| 🎨 Color Settings       |               |                       |
| 🖥️ Display Settings    |               |                       |
| 🔊 Audio Settings       |               |                       |
| ⚙️ Other Settings      |               |                       |
| ★ Personalize          |               |                       |

 Resolution: 1920x1080 @ 60Hz

Allows you to adjust shortcut button for: 1. Brightness & Contrast and 2. Preset Modes.

### OSD Warning Messages

The following warning messages may appear on the screen to indicate that the monitor is out of synchronization.

MESSAGE
Dell SX2210T

The current input timing is not supported by the monitor display.  
Please change your input timing to **1920x1080@60Hz** or any other monitor listed timing as per the monitor specifications.



MESSAGE
Dell SX2210T

The current input timing is not supported by the monitor display.  
Please change your input timing to **1920x1080@60Hz** or any other monitor listed timing as per the monitor specifications.



MESSAGE
Dell SX2210T

The current input timing is not supported by the monitor display.  
Please change your input timing to **1920x1080@60Hz** or any other monitor listed timing as per the monitor specifications.



This means that the monitor cannot synchronize with the signal that it is receiving from the computer. Either the signal is too high or too low for the monitor to use. See [Specifications](#) for the Horizontal and Vertical frequency ranges addressable by this monitor. Recommended mode is 1920 X 1080 at 60Hz.

When monitor enters Power Save mode, one of the following messages appears :

MESSAGE
Dell SX2210T

Entering Power Save Mode.





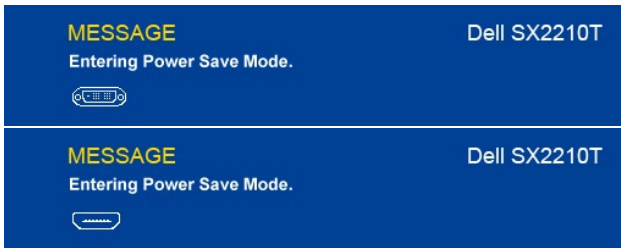

If you press any button other than the Power button one of the following messages will appear depending on the selected input:

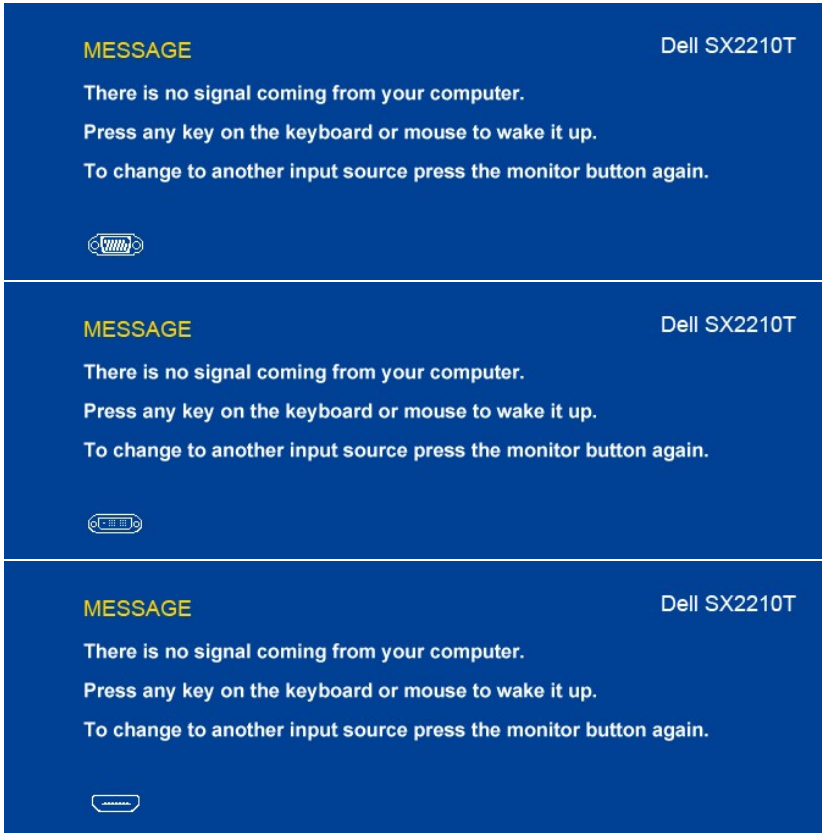

See [Solving Problem](#)

---

[s](#) for more information.

## Setting the Maximum Resolution

To set the maximum resolution for the monitor:

1. Right-click on the desktop and select **Properties**.
2. Select the **Settings** tab.
3. Set the screen resolution to 1920 x 1080.
4. Click **OK**.

If you do not see 1920 x 1080 as an option, you may need to update your graphics driver. Depending on your computer, complete one of the following procedures:

1. If you have a Dell desktop or portable computer:
  - o Go to [support.dell.com](http://support.dell.com), enter your service tag, and download the latest driver for your graphics card.
1. If you are using a non-Dell computer (portable or desktop):
  - o Go to the support site for your computer and download the latest graphic drivers.
  - o Go to your graphics card website and download the latest graphic drivers.

---

## Using the Dell Soundbar (Optional)

The Dell Soundbar is a stereo two channel system, mountable on Dell Flat Panel Displays. The Soundbar has a rotary volume and on/off control to adjust the overall system level, a LED for power indication, and two audio headset jacks.

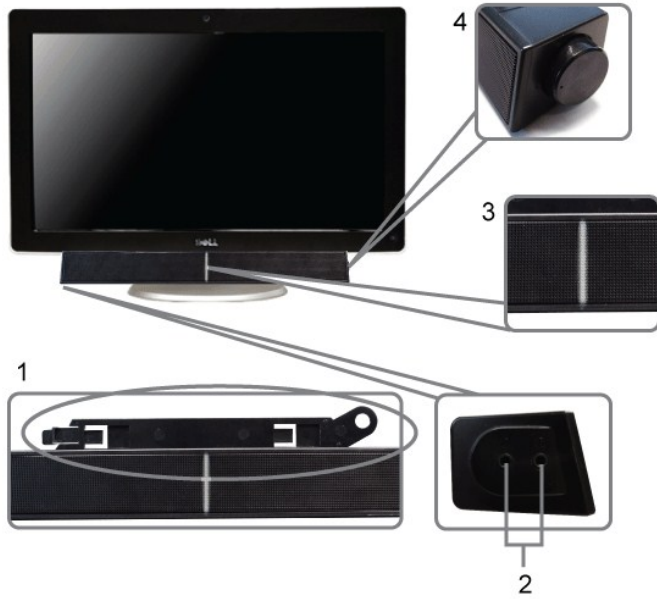

1. Attach mechanism
2. Headphone connectors
3. Power indicator
4. Power/Volume control

---

## Using the Tilt

### Tilt

With the built-in stand, you can tilt the monitor for the most comfortable viewing angle.

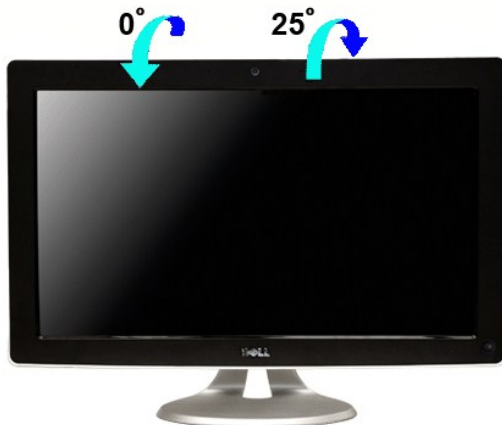

 **NOTE:** The stand is attached when the monitor is shipped from the factory.

---

## Using the Camera

### Installing the Dell TouchCam Software (Microsoft® Windows® Operating Systems)

The Dell SX2210T webcam application media that shipped with your monitor, allows you to install the software and drivers for the integrated webcam.

To install the **Dell TouchCam Software**:

1. Insert the Dell "**Drivers and Documentation**" CD into the drive.
2. Choose "**TouchCam Software**".
3. The **Install Shield Wizard** automatically launches the setup application. Click **Next** to continue.
4. Read **Software License Agreement** and click **Yes** to continue. Click **Next** to continue.
5. Click **Next** to continue.
6. Click **Finish** to complete installation.

**NOTE:** All instant messaging softwares have to close before the installation can begin.

You are now ready to use the Webcam.

---

## Using the TouchCam Software

### Stand-alone mode

Stand-alone mode can be launched from the start menu.

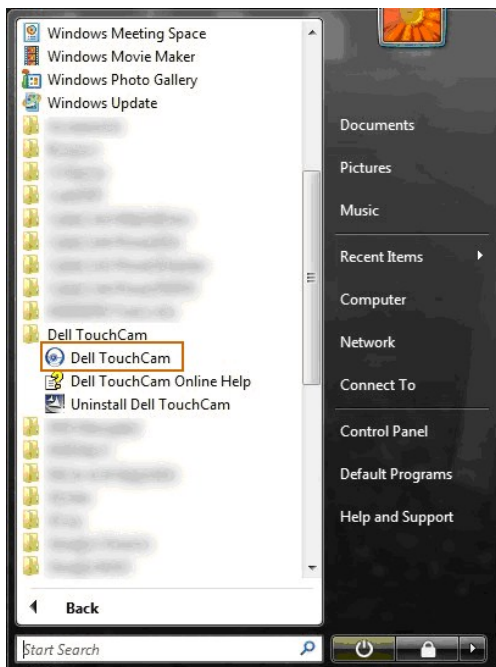

### IM mode

IM mode will launch itself automatically when an instant messaging program begins a video call session.

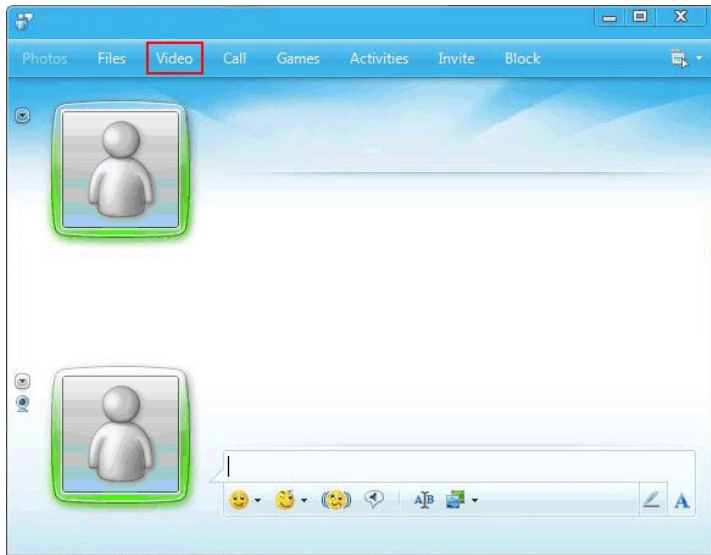

When a video session ends, the TouchCam software will return to stand-alone mode.

### Setting up TouchCam in instant messaging programs

The following describes the setup procedures for Windows Live Messenger.

1. Click **Tool**→**Audio and video setup...**

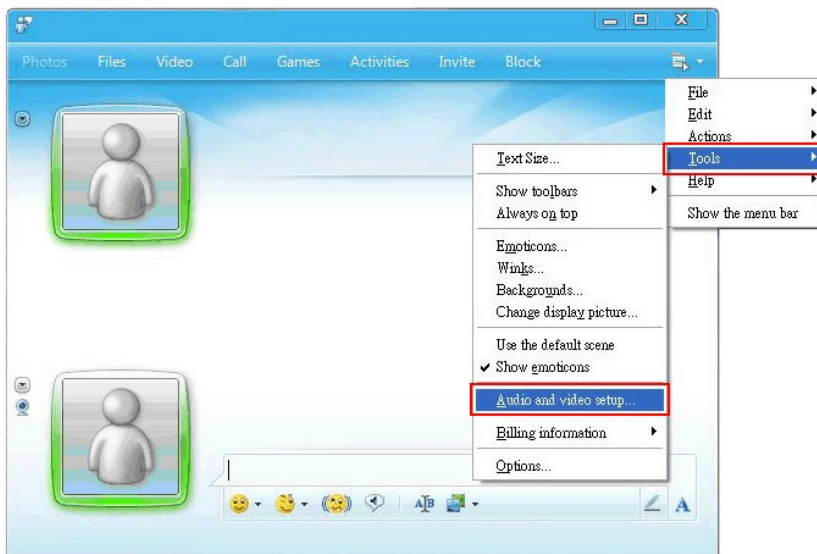

2. Select **Dell Web Camera Filter**.

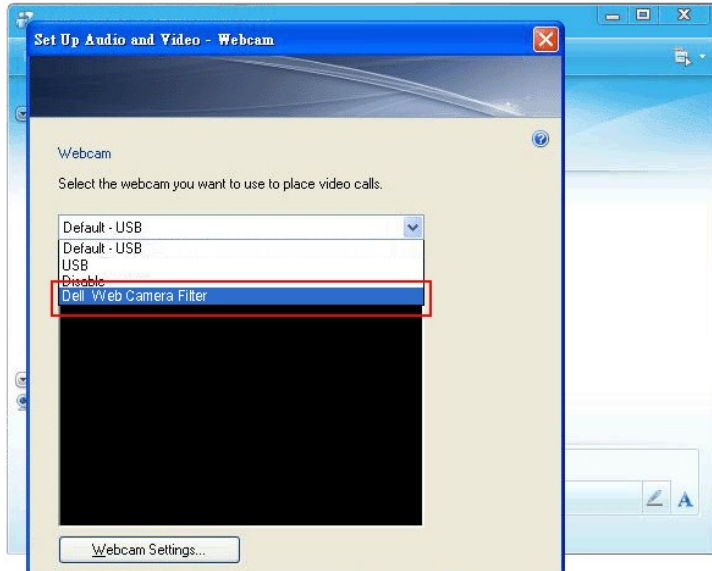

Similar setup steps can be performed in other IM programs.

---

## Installing and Using the Facial Recognition Software (FastAccess)

### Installing the Facial Recognition Software (FastAccess) (Windows Vista® and Window 7 Operating Systems Only)

To install the **Facial Recognition Software (FastAccess)**:

1. Insert the Dell "**Drivers and Documentation**" CD into the drive.
1.  **NOTE:** Ensure that the USB cable is connected between the monitor and the computer.
2. Choose "**Facial Recognition Software**".
3. The **Install Shield Wizard** automatically launches the setup application. Select the **Language** and click **Next** to continue.
4. Read **Software License Agreement** and click **Yes** to continue.
5. Click **Browse** to change **Destination Folder** where the software will be installed to and then click **Next** to continue.
6. Choose **Full Installation** than click **Next** and follow the instructions to complete the installation. Alternatively, choose **Custom Installation** to select the components to install.
7. Click **Finish** to restart the computer after installation completes.

You are now ready to use the Facial Recognition Software.

### First Use

1. From the Start Menu; click Start→All Programs→FastAccess→Configure FastAccess.
2. Follow the on-screen setup wizard to begin using FastAccess face recognition.
3. FastAccess automatically learns your face when you login to Vista or Windows 7. You will be able to log in to your computer automatically on most occasions, without having to enter a password.

### Customizing FastAccess

To help keep FastAccess secure, features affecting overall system security and certain advanced features can only be changed if you have Vista administrator rights.

- 1 **Configuration Console:** Allows changing the Security Level, Web Logins and Advanced features. Only administrator accounts have access to the Configuration Console.
- 1 **User Settings:** Allows changing Web Logins and Notification Messages. Only Vista user accounts have access to User Settings.

### Configuration Console: Security

The main security features of FastAccess are controlled by the Security Level Adjustment slider. As you move the slider from left to right, you turn on FastAccess and add increasing levels of security. As you move this slider, a brief description of the operating modes are displayed below the slider. You may set the following four security levels:

1. Disabled
2. Face Login (Factory default setting)
3. User Switching
4. Continuous Security

**OK button:** This button closes the Console and saves all changes.

**Cancel button:** This button closes the Console without saving any changes.

## Choosing the Desired Webcam for Face Recognition

- 1 **Automatic Webcam Selection:** Automatic Webcam Selection simplifies operation if more than one webcam is installed on your computer. FastAccess connects to a Dell Monitor webcam first.
- 1 **Manual Webcam Selection:** Your desired webcam can be selected by opening the "FastAccess Configuration Console" and clicking the "Advanced" button. Next click the "Camera Selection" link and select the desired webcam.

## Using the Automatic Web Login

The Web Login Vault feature allows FastAccess to remember user names and passwords for many of the websites that require a login. The Web Login Vault will automatically enter the user name and password for a website.

The first time you enter a user name and password into a website with a login, FastAccess will present a small pop-up box. This box allows you to Keep On or Turn Off the Web Login Vault.

## Security Recommendations

We recommend FastAccess be set to use the "Face + Password" feature. Face + Password periodically requires your password in addition to your face. This provides better security than any biometric or password alone.

---

## Using the Touch Screen

 **NOTE:** Ensure that the USB cable is connected between the monitor and the computer.

The Dell™ SX2210T Flat Panel Monitor is touch sensitive—you can control the computer simply by touching the screen.

The touch screen allows you to interact with the computer in a similar way to a mouse as follows:

- 1 Tap the screen once for a single mouse click.
- 1 Tap the screen twice in quick succession for a double mouse click.
- 1 Touch down and then move your finger to drag an object.
- 1 Touch and hold for a right mouse click.
- 1 To select a menu option, touch down on the menu, then move your finger to the required option, then lift your finger to select the option. Alternatively, tap the menu, then tap the option required as you do with a mouse.

The touch screen does not require pressure to sense a touch. For best results, point at roughly right angles to the screen and keep the rest of your hand clear of the glass.

---

## Using the Touch Screen Tools

The Touch Screen Tools provides restore to factory defaults, diagnostic and calibrating functions that can be used for troubleshooting touch-screen problems.

To install the **Touch Screen Tools** software:

1. Insert the Dell "Drivers and Documentation" CD into the drive.

 **NOTE:** Ensure that the USB cable is connected between the monitor and the computer.

2. Choose "Touch Screen Tools".
3. Follow the on-screen instructions to install **Touch Screen Tools** software.

You are now ready to use the **Touch Screen Tools** Software and the Touch Screen Gestures.

Once installed, the **Touch Screen Tools** has an icon in the task bar that allows you to access the [Touch Screen Tools Settings](#).



## Touch Screen Tools Settings

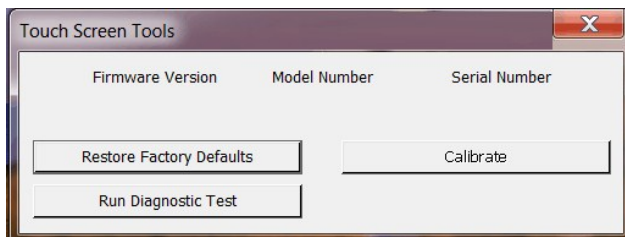

If the cursor does not move correctly when you touch the screen, see [Touch Screen problems](#).

The page displays information and provides functions used for touch function technical support.

1 **[Restore factory defaults] button**

Sets the Touch Screen Tools settings to factory defaults.

1 **[Run diagnostics test] button**

Runs a diagnostic test on the touch screen and displays the result. For further information, see [Diagnostic Test](#).

1 **[Calibrate] button**

Initiates the touch screen calibration procedure. See [Calibrating the Touch Screen](#).

---

[Back to Contents Page](#)

[Back to Contents Page](#)

## Setting Up Your Monitor

**Dell™ SX2210T Flat Panel Monitor**

---

### Setting the display resolution to 1920 x 1080 (Maximum)

For optimal display performance while using the Microsoft® Windows® operating systems, set the display resolution to 1920 x 1080 pixels by performing the following steps:

1. Right-click on the desktop and click **Properties**.
2. Select the **Settings** tab.
3. Move the slider-bar to the right by pressing and holding left-mouse button and adjust the screen resolution to **1920 X 1080**.
4. Click **OK**.

If you do not see **1920 x 1080** as an option, you may need to update your graphics driver. Please choose the scenario below that best describes the computer system you are using, and follow the provided directions:

**1: [If you have a Dell™ desktop or a Dell™ portable computer with internet access.](#)**

**2: [If you have a non Dell™ desktop, portable computer, or graphics card.](#)**

---

[Back to Contents Page](#)



# Dell™ SX2210T Flat Panel Monitor

[User Guide](#)

[Setting the display resolution to 1920 x 1080 \(Maximum\)](#)

---

Information in this document is subject to change without notice.  
© 2009 Dell Inc. All rights reserved

Reproduction of these materials in any manner whatsoever without the written permission of Dell Inc. is strictly forbidden.

Trademarks used in this text: *DELL* and the *DELL* logo are trademarks of Dell Inc; *Microsoft*, *Windows*, and *Windows Vista* are either registered trademarks or trademarks of Microsoft Corporation in the United States and/or other countries; *ENERGY STAR* is a registered trademark of the U.S. Environmental Protection Agency. As an ENERGY STAR partner, Dell Inc. has determined that this product meets the ENERGY STAR guidelines for energy efficiency.

Other trademarks and trade names may be used in this document to refer to either the entities claiming the marks and names or their products. Dell Inc. disclaims any proprietary interest in trademarks and trade names other than its own.

---

Model SX2210Tb

August 2009 Rev. A00

## Setting Up the Monitor

Dell™ SX2210T Flat Panel Monitor User's Guide

- [Connecting the Monitor](#)
  - [Organizing Your Cables](#)
  - [Attaching the Soundbar \(Optional\)](#)
- 

### Connecting Your Monitor

**⚠ CAUTION:** Before you begin any of the procedures in this section, follow the [Safety Instructions](#).

**🔌 NOTE:** USB uplink cable needs to be connected for touch function; integrated camera and microphone to work.

To connect your monitor to the computer:

1. Turn off your computer and disconnect the power cable.
2. Connect the HDMI cable, white (digital DVI-D), or blue (analog VGA) display connector cable to the corresponding video port on the back of your computer. Do not use all the cables on the same computer. Use all of the cables only when they are connected to different computers with appropriate video systems.

#### Connecting the Blue VGA Cable



#### Connecting the White DVI Cable



#### Connecting the HDMI Cable



**NOTE:** The graphics are used for the purpose of illustration only. Appearance of the computer may vary.

## Connecting the USB Cable

After you have completed connecting the DVI/VGA/HDMI cable, follow the procedure below to connect the USB cable to the computer and complete your monitor setup:

1. Connect the downstream USB connector (cable supplied) to an appropriate USB connector on your computer.
2. Connect USB peripherals to the upstream USB connectors on the monitor.
3. Plug the power cables for your computer and monitor into a nearby outlet.
4. Turn on the monitor and the computer.
5. If your monitor displays an image, installation is complete. If it does not display an image, see [Solving Problems](#).
6. Use the cable holder on the monitor stand to organize the cables.



---

## Organizing Your Cables



After attaching all necessary cables to your monitor and computer, (see [Connecting Your Monitor](#)) use the cable management slot to organize all cables as shown above.

---

## Attaching the Soundbar (Optional)



🔔 **NOTICE:** Do not use with any device other than the Dell Soundbar.

To attach the soundbar:

1. Working from the back of the monitor, attach Soundbar by aligning the two slots with the two tabs along the bottom of the monitor.
  2. Slide the Soundbar to the left until it snaps into place.
  3. Connect the Soundbar with the DC power connector from the Soundbar Power adapter.
  4. Insert the mini stereo plug from the back of the Soundbar into the computer's audio output jack.
- 

[Back to Contents Page](#)

[Back to Contents Page](#)

## Troubleshooting

### Dell™ SX2210T Flat Panel Monitor

- [Self-Test](#)
- [Common Problems](#)
- [Product-Specific Problems](#)
- [Universal Serial Bus Specific Problems](#)
- [Dell Soundbar Problems](#)
- [Camera Problems](#)
- [Dell TouchCam Problems](#)
- [Facial Recognition \(FastAccess\) Problems](#)
- [Touch Screen Problems](#)

**⚠ CAUTION:** Before you begin any of the procedures in this section, follow the [Safety Instructions](#).

---

### Self-Test

Your monitor provides a self-test feature that allows you to check whether your monitor is functioning properly. If your monitor and computer are properly connected but the monitor screen remains dark, run the monitor self-test by performing the following steps:

1. Turn off both your computer and the monitor.
2. Unplug the video cable from the back of the computer or monitor. To ensure proper Self-Test operation, remove the HDMI, Digital (white connector), and the Analog (blue connector) cables from the back of the computer or monitor.
3. Turn on the monitor.

The floating dialog box should appear on-screen (against a black background) if the monitor cannot sense a video signal and is working correctly. While in self-test mode, the power LED remains white. Also, depending upon the selected input, one of the dialogs shown below will continuously scroll through the screen.

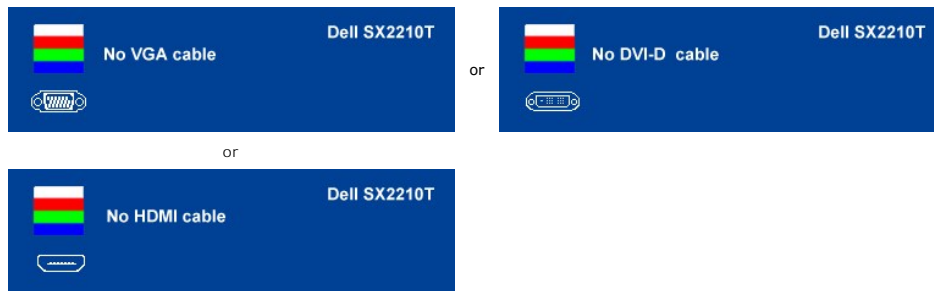

4. This box also appears during normal system operation, if the video cable becomes disconnected or damaged.
5. Turn off your monitor and reconnect the video cable; then turn on both your computer and the monitor.

If your monitor screen remains blank after you use the previous procedure, check your video controller and computer, because your monitor is functioning properly.

---

### Built-in Diagnostics

Your monitor has a built-in diagnostic tool that helps you determine if the screen abnormality you are experiencing is an inherent problem with your monitor, or with your computer system and graphic card.

**🔧 NOTE:** You can run the built-in diagnostics only when the video cable is unplugged and the monitor is in *self-test mode*.

To run the built-in diagnostics:

1. Ensure that the screen is clean (no dust particles on the surface of the screen).
2. Unplug the video cable(s) from the back of the computer or monitor. The monitor then goes into the self-test mode.
3. On the front panel, press and hold the **shortcut key 1** and **shortcut key 4** keys on the front panel, simultaneously for 2 seconds. A gray screen appears.

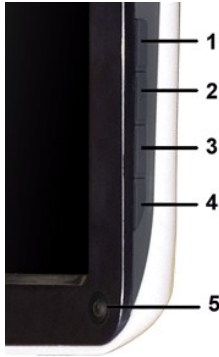

4. Carefully inspect the screen for abnormalities.
5. Press the **shortcut key 4** key on the front panel again. The color of the screen changes to red.
6. Inspect the display for any abnormalities.
7. Repeat steps 5 and 6 to inspect the display in green, blue, and white colored screens.

The test is complete when the white screen appears. To exit, press the **shortcut key 4** key again.

If you do not detect any screen abnormalities upon using the built-in diagnostic tool, the monitor is functioning properly. Check the video card and computer.

## Common Problems

The following table contains general information about common monitor problems you might encounter and the possible solutions.

| Common Symptoms           | What You See                          | Possible Solutions   |
|---------------------------|---------------------------------------|--|
| No Video/Power LED off    | No picture                            | <ul style="list-style-type: none"> <li>1 Ensure that the video cable connecting the monitor and the computer is properly connected and secure.</li> <li>1 Verify that the power outlet is functioning properly using any other electrical equipment.</li> </ul>  |
| No Video/Power LED on     | No picture or no brightness           | <ul style="list-style-type: none"> <li>1 Increase brightness &amp; contrast controls via OSD.</li> <li>1 Perform monitor self-test feature check.</li> <li>1 Check for bent or broken pins in the video cable connector.</li> <li>1 Press Shortcut key 4 to call out the Input Select Source OSD menu. Select the correct input source.</li> <li>1 Run the built-in diagnostics.</li> </ul>  |
| Poor Focus                | Picture is fuzzy, blurry, or ghosting | <ul style="list-style-type: none"> <li>1 Perform Auto Adjust via OSD.</li> <li>1 Adjust the Phase and Pixel Clock controls via OSD.</li> <li>1 Eliminate video extension cables.</li> <li>1 Reset the monitor to Factory Settings.</li> <li>1 Change the video resolution to the correct aspect ratio (16:9).</li> </ul>   |
| Shaky/Jittery Video       | Wavy picture or fine movement         | <ul style="list-style-type: none"> <li>1 Perform Auto Adjust via OSD.</li> <li>1 Adjust the Phase and Pixel Clock controls via OSD.</li> <li>1 Reset the monitor to Factory Settings.</li> <li>1 Check environmental factors.</li> <li>1 Relocate the monitor and test in another room.</li> </ul>   |
| Missing Pixels            | LCD screen has spots                  | <ul style="list-style-type: none"> <li>1 Cycle power on-off.</li> <li>1 Pixel that is permanently off is a natural defect that can occur in LCD technology.</li> <li>1 Run the built-in diagnostics</li> </ul>   |
| Stuck-on Pixels           | LCD screen has bright spots           | <ul style="list-style-type: none"> <li>1 Cycle power on-off.</li> <li>1 Pixel that is permanently off is a natural defect that can occur in LCD technology.</li> <li>1 Run the built-in diagnostics</li> </ul>   |
| Brightness Problems       | Picture is too dim or too bright      | <ul style="list-style-type: none"> <li>1 Reset the monitor to <a href="#">Factory Settings</a>.</li> <li>1 Auto Adjust via OSD.</li> <li>1 Adjust brightness &amp; contrast controls via OSD.</li> </ul>   |
| Geometric Distortion      | Screen is not centered correctly      | <ul style="list-style-type: none"> <li>1 Reset the monitor to Factory Settings.</li> <li>1 Auto Adjust via OSD.</li> <li>1 Adjust brightness &amp; contrast controls via OSD.</li> </ul> <p><b>NOTE:</b> When using 'DVI-D' or 'HDMI', the positioning adjustments are not available.</p>  |
| Horizontal/Vertical Lines | Screen has one or more lines          | <ul style="list-style-type: none"> <li>1 Reset the monitor to Factory Settings.</li> <li>1 Perform Auto Adjust via OSD.</li> <li>1 Adjust Phase and Pixel Clock controls via OSD.</li> <li>1 Perform monitor self-test feature check and determine if these lines are also in self-test mode.</li> <li>1 Check for bent or broken pins in the video cable connector.</li> <li>1 Run the built-in diagnostics</li> </ul> <p><b>NOTE:</b> When using 'DVI-D' or 'HDMI', the Pixel Clock and Phase adjustments are not available.</p> |
| Synchronization Problems  | Screen is scrambled or appears torn   | <ul style="list-style-type: none"> <li>1 Reset the monitor to Factory Settings.</li> <li>1 Perform Auto Adjust via OSD.</li> <li>1 Adjust Phase and Pixel Clock controls via OSD.</li> <li>1 Perform monitor self-test feature check to determine if the scrambled screen appears in self-test mode.</li> <li>1 Check for bent or broken pins in the video cable connector.</li> <li>1 Restart the computer in the <i>safe mode</i>.</li> </ul>  |

|   |  |   |
|---|--|---|
| Safety Related Issues   | Visible signs of smoke or sparks                                   | <ul style="list-style-type: none"> <li>1 Do not perform any troubleshooting steps.</li> <li>1 Contact Dell immediately.</li> </ul>  |
| Intermittent Problems   | Monitor malfunctions on & off                                      | <ul style="list-style-type: none"> <li>1 Ensure that the video cable connecting the monitor to the computer is connected properly and is secure.</li> <li>1 Reset the monitor to Factory Settings.</li> <li>1 Perform monitor self-test feature check to determine if the intermittent problem occurs in self-test mode.</li> </ul>   |
| Missing Color   | Picture lacks color  | <ul style="list-style-type: none"> <li>1 Perform monitor <a href="#">self-test</a> feature check.</li> <li>1 Ensure that the video cable connecting the monitor to the computer is connected properly and is secure.</li> <li>1 Check for bent or broken pins in the video cable connector.</li> <li>1 Run the built-in diagnostics</li> </ul>  |
| Wrong Color   | Picture color not good   | <ul style="list-style-type: none"> <li>1 Change the Color Setting Mode in the <a href="#">Color Settings OSD</a> to Graphics or Video depending on the application.</li> <li>1 Try a different Color Preset Setting in Color Settings OSD. Adjust R/G/B value in Color Settings OSD if the Color Management is turned off.</li> <li>1 Change the Input Color Format to PC RGB or YPbPr in the Advance Setting OSD.</li> <li>1 Run the built-in diagnostics</li> </ul> |
| Image retention from a static image left on the monitor for a long period of time | Faint shadow from the static image displayed appears on the screen | <ul style="list-style-type: none"> <li>1 Use the Power Management feature to turn off the monitor at all times when not in use (for more information, see <a href="#">Power Management Modes</a>).</li> <li>1 Alternatively, use a dynamically changing screensaver.</li> </ul>   |

## Product-Specific Problems

| Specific Symptoms  | What You See   | Possible Solutions  |
|--|--|---|
| Screen image is too small                                  | Image is centered on screen, but does not fill entire viewing area                                 | <ul style="list-style-type: none"> <li>1 Reset the monitor to Factory Settings.</li> </ul>  |
| Cannot adjust the monitor with the keys on the front panel | OSD does not appear on the screen  | <ul style="list-style-type: none"> <li>1 Turn off the monitor, unplug the power cord, plug back, and then turn on the monitor.</li> </ul>   |
| No Input Signal when user controls are pressed             | No picture, the LED light is white. When you press "up", "down" or "Menu" key, the message appears | <ul style="list-style-type: none"> <li>1 Check the signal source. Ensure that the Computer is not in the power saving mode by moving the mouse or pressing any key on the keyboard.</li> <li>1 <b>Check whether the signal cable is plugged in properly. Re-plug</b> the signal cable if necessary.</li> <li>1 Reset the computer or video player.</li> </ul> |
| The picture does not fill the entire screen.               | The picture cannot fill the height or width of the screen  | <ul style="list-style-type: none"> <li>1 Due to different video formats (aspect ratio) of DVDs, the monitor may display in full screen.</li> <li>1 Run the built-in diagnostics</li> </ul>  |

 **NOTE:** When choosing DVI-D or HDMI mode, the **Auto Adjust** function is not available.

## Universal Serial Bus (USB) Specific Problems

| Specific Symptoms                     | What You See  | Possible Solutions   |
|---------------------------------------|---|--|
| USB interface is not working          | USB peripherals are not working                                     | <ul style="list-style-type: none"> <li>1 Check that your monitor is turned ON.</li> <li>1 <b>Reconnect the upstream cable to your computer.</b></li> <li>1 <b>Reconnect the USB peripherals (downstream connector).</b></li> <li>1 Switch off and then turn on the monitor again.</li> <li>1 Reboot the computer.</li> <li>1 Some USB devices like external portable HDD require higher electric current; connect the device directly to the computer system.</li> </ul> |
| High Speed USB 2.0 interface is slow. | High Speed USB 2.0 peripherals working slowly or not working at all | <ul style="list-style-type: none"> <li>1 Check that your computer is USB 2.0-capable.</li> <li>1 Some computers have both USB 2.0 and USB 1.1 ports. Ensure that the correct USB port <b>is used.</b></li> <li>1 <b>Reconnect the upstream cable to your computer.</b></li> <li>1 <b>Reconnect the USB peripherals (downstream connector).</b></li> <li>1 Reboot the computer.</li> </ul>  |

## Dell™ Soundbar Problems

| Common Symptoms | What You See                               | Possible Solutions  |
|-----------------|--|---|
| No Sound        | Soundbar has power - power indicator is on | <ul style="list-style-type: none"> <li>1 Plug the audio line-in cable into the computer's audio out jack.</li> <li>1 Set all volume controls to their maximum and ensure that the mute option is not enabled.</li> <li>1 Play some audio content on the computer (example, audio CD, or MP3).</li> <li>1 Turn the Power/Volume knob on the Soundbar clockwise to a higher volume setting.</li> <li>1 Clean and reseal the audio line-in plug.</li> <li>1 Test the Soundbar using another audio source (For example: portable CD player, MP3 player).</li> </ul> |

|                         |   |  |
|-------------------------|---|--|
| Distorted Sound         | Computer's sound card is used as the audio source | <ul style="list-style-type: none"> <li>1 Clear any obstructions between the Soundbar and the user.</li> <li>1 Confirm that the audio line-in plug is completely inserted into the jack of the sound card.</li> <li>1 Set all Windows volume controls to their midpoints.</li> <li>1 Decrease the volume of the audio application.</li> <li>1 Turn the Power/Volume knob on the Soundbar counter-clockwise to a lower volume setting.</li> <li>1 Clean and reseal the audio line-in plug.</li> <li>1 Troubleshoot the computer's sound card.</li> <li>1 Test the Soundbar using another audio source (For example: portable CD player, MP3 player).</li> <li>1 Avoid using an audio cable extension or audio jack converter.</li> </ul> |
| Distorted Sound         | Other audio source is used                        | <ul style="list-style-type: none"> <li>1 Clear any obstructions between the Soundbar and the user.</li> <li>1 Confirm that the audio line-in plug is completely inserted into the jack of the audio source.</li> <li>1 Decrease the volume of the audio source.</li> <li>1 Turn the Power/Volume knob on the Soundbar counter-clockwise to a lower volume setting.</li> <li>1 Clean and reseal the audio line-in plug.</li> </ul>  |
| Unbalanced Sound Output | Sound from only one side of Soundbar              | <ul style="list-style-type: none"> <li>1 Clear any obstructions between the Soundbar and the user.</li> <li>1 Confirm that the audio line-in plug is completely inserted into the jack of the sound card or audio source.</li> <li>1 Set all Windows audio balance controls (L-R) to their midpoints.</li> <li>1 Clean and reseal the audio line-in plug.</li> <li>1 Troubleshoot the computer's sound card.</li> <li>1 Test the Soundbar using another audio source (For example: portable CD player, MP3 player).</li> </ul>   |
| Low Volume              | Volume is too low                                 | <ul style="list-style-type: none"> <li>1 Clear any obstructions between the Soundbar and the user.</li> <li>1 Turn the Power/Volume knob on the Soundbar clockwise to the maximum volume setting.</li> <li>1 Set all Windows volume controls to their maximum.</li> <li>1 Increase the volume of the audio application.</li> <li>1 Test the Soundbar using another audio source (For example: portable CD player, MP3 player).</li> </ul>  |

## Camera Problems

| COMMON SYMPTOMS                    | WHAT YOU EXPERIENCE  | POSSIBLE SOLUTIONS   |
|------------------------------------|--|--|
| No Power                           | The camera is not working and the LED is off                     | <p>If the monitor has no power, see <a href="#">Troubleshooting Your Monitor</a>.</p> <p>Verify if the camera is detected by Windows.<br/>Reinstall the camera drives using the Dell SX2210T <i>Webcam Resource CD</i>. See <a href="#">Using the Camera</a> for more information.</p>   |
| Camera is not detected             | The camera is not working and the LED is on                      | <p>Remove and insert the USB cable.</p> <p>Reinstall the <b>Dell TouchCam Software</b>. See <a href="#">installing the Dell TouchCam Software</a> for more information.</p>  |
| Poor Focus                         | The camera captures fuzzy or unclear videos and pictures         | <p>Clean the camera surface using a damp, soft lint-free cloth.</p> <p>Increase the available ambient light or change the source of light.</p> <p>Reset the camera defaults through the <b>Dell TouchCam Software</b>. See <a href="#">Using the Camera</a> for more information.</p> <p>Ensure that the <b>Color Depth</b> settings in <b>Display Properties</b> is set to <b>16-bit color or higher</b>.<br/><b>NOTE:</b> Lower color depth settings result in poor-quality images.<br/><b>NOTE:</b> The integrated webcam operates at a lower resolution than most commercially available digital cameras. Most commercial digital cameras are 4 mega pixel or higher. The integrated webcam operates up to 2.0 mega pixel.</p> |
| Poor quality video on the Internet | The camera captures grainy images while using it on the Internet | <p>Check your internet connection speed. A slow internet connection could cause similar problems with the video. It is recommended to use a broadband connection with good throughput.</p>   |
| Color Problem                      | The images are tinted red, blue, or green                        | <p>Reset the camera defaults through the <b>Dell TouchCam</b>.</p> <p>In Dell TouchCam, go to <b>Settings</b>→<b>Display</b> tab→<b>Advanced Settings</b>, reset to webcam defaults by clicking the <b>Default</b> button.</p> <p>Adjust the camera color settings through <b>Dell Webcam Central</b>.</p> <p>In Dell TouchCam, go to <b>Settings</b>→<b>Display</b> tab→<b>Advanced Settings</b>, make adjustment to webcam properties.</p>   |
| No Image                           | Blank screen   | <p>Increase the available ambient light, change the direction of the camera, or change the source of light.</p> <p>Reset the camera defaults through the <b>Dell TouchCam</b>.</p> <p>In Dell TouchCam, go to <b>Settings</b>→<b>Display</b> tab→<b>Advanced Settings</b>, reset to webcam defaults by clicking the <b>Default</b> button.</p> <p>Adjust the contrast levels using the <b>Dell TouchCam</b>.</p> <p>In Dell TouchCam, go to <b>Settings</b>→<b>Display</b> tab, make contrast adjustment using the horizontal slide bar.</p>   |



|                                       |   |  |
|---------------------------------------|---|--|
|                                       |   | Restart Windows operating system and ensure the camera is detected correctly by the Windows operating system.  |
| Slow frame rate in video capture mode | The capture video is not smooth                   | The video capture is a resource intensive task, try adjusting <b>Capture quality</b> to experiment with video capture outputs.<br>In Dell TouchCam, go to <b>Settings</b> , make adjustment to <b>Capture quality</b> box.<br>Install the latest DirectX.  |
| Audio and video is not synchronized   | The captured video and audio are not synchronized | The video capture is a resource intensive task, try adjusting <b>Capture quality</b> to experiment with video capture outputs.<br>In Dell TouchCam, go to <b>Settings</b> , make adjustment to <b>Capture quality</b> box.   |
| Microphone is not working             | The webcam captures video but not sound           | Speak from closer to the microphone.<br><b>The integrated microphone is designed to have a wider reception area for recording. But it still has its limits. Try moving closer to the microphone or ensure that you are within the recording area for the microphone.</b><br>Check if the volume is muted. To enable sound:<br>1. Click <b>Start</b> → <b>Control Panel</b> → <b>Sound and Audio Devices</b> .<br>2. Click to uncheck the box next to <b>Mute</b> .<br>Set the correct audio source in <b>Dell TouchCam Software</b> . To select the correct audio source:<br>1. In the <b>Dell TouchCam</b> , navigate to configure settings by clicking on the <b>Settings</b> button.<br>2. Select <b>Monitor Webcam</b> in the <b>Audio Device</b> box.<br>3. Make sure <b>Capture with audio</b> is checked.<br>Test the microphone. Try testing the microphone using an application other than the <b>Dell TouchCam Software</b> . To test the microphone,<br>1. Click <b>Start</b> → <b>Control Panel</b> → <b>Sound and Audio Devices</b> .<br>2. Click the <b>Voice</b> tab.<br>3. Click the <b>Test Hardware</b> button and follow the instructions.<br>If the recording is successful, reset the camera defaults or reinstall the <b>Dell TouchCam Software</b> . See <a href="#">Using the Camera</a> for more information. |

## Dell TouchCam Problems

| Common Symptoms   | Possible Solutions  |
|---|---|
| Unable to upload videos to YouTube                                    | <ul style="list-style-type: none"> <li>1 You will need to register a YouTube account before you are able to upload a video to YouTube. You adhere to all copyright terms as specified by YouTube. You are advised to check the copyright status of any video, and any included music, that you are about to upload to YouTube. Neither YouTube nor Dell is responsible for the video content you uploaded to YouTube.</li> </ul>  |
| Unable to see my webcam video on Dell TouchCam                        | <ul style="list-style-type: none"> <li>1 Please close all applications that may use the webcam before you use Dell TouchCam, and check that the webcam has been setup properly on your PC. You must choose "Dell Web Camera Filter" from your instant software setting.</li> </ul>  |
| No sound when using Dell TouchCam with my instant messaging software  | <ul style="list-style-type: none"> <li>1 Navigate to the Volume Control by clicking Start→Programs→Accessories→Entertainment→Volume Control. In the Volume Control window, please check that the system volume is not muted. Also make sure the system volume is set to the correct levels, for both the Master Volume, as well as the Wave volume.</li> </ul>  |
| PowerPoint image is backwards when I use TouchCam share file function | <ul style="list-style-type: none"> <li>1 This is due to the default setting in MSN is to set the webcam image as a mirror image. Please check the following steps to solve this problem. <ul style="list-style-type: none"> <li>1 In the Windows Live Messenger main window, select Tools→Audio video setup.</li> <li>1 In the Audio and Video Setup wizard, uncheck Mirror my image</li> <li>1 Click the Finish button to save your changes and enable Dell TouchCam.</li> </ul> </li> </ul>   |
| The Avatar function is not tracking me correctly                      | <ul style="list-style-type: none"> <li>1 Dell TouchCam's facial tracking ability for avatars may decline when you move rapidly or move out of the webcam frame. When the facial tracking result is lost (the avatar's actions does not sync with you), please calibrate by placing your face in the center of the webcam video frame and then look straight at the webcam. Dell TouchCam will automatically re-calibrate the facial tracking.</li> </ul>  |
| Where to download additional effects                                  | <ul style="list-style-type: none"> <li>1 After installing Dell TouchCam you can download additional free Emotion effects from DirectorZone. These effects were carefully designed to enhance fun video effects during video communication.<br/><a href="http://directorzone.cyberlink.com/">http://directorzone.cyberlink.com/</a></li> </ul>   |
| Unable to record video higher than 640x480                            | <ul style="list-style-type: none"> <li>1 Dell TouchCam supports video recording up to video size of 640x480 only.</li> </ul>  |
| Unable to use TouchCam with instant messaging software                | <ul style="list-style-type: none"> <li>1 <b>Windows Live Messenger</b> <ul style="list-style-type: none"> <li>1. In the Windows Live Messenger main window, select Tools→Audio video setup.</li> <li>2. In Step 3 of the Audio and Video Setup wizard, select <b>Dell Web Camera Filter</b> from the select webcam drop-down menu.</li> <li>3. Click the Finish button to save your changes</li> </ul> </li> <li>1 <b>Yahoo! Messenger</b> <ul style="list-style-type: none"> <li>1. In the Yahoo Messenger main window, select Actions→Invite to View My webcam</li> <li>2. My WebCam→Preferences→WebCam→Camera Source→In this page, select <b>Dell Web Camera Filter</b> from the select webcam drop-down menu.</li> <li>3. Click the Finish button to save your changes</li> </ul> </li> <li>1 <b>Skype</b> <ul style="list-style-type: none"> <li>1. In the Skype main window, select Privacy→Calls→Video Settings</li> <li>2. In this page, select <b>Dell Web Camera Filter</b> from the select webcam drop-down menu.</li> </ul> </li> </ul> |

|  |  |
|--|--|
|  | <p>3. Click the Finish button to save your changes</p> <p>1 <b>AOL Instant Messenger</b></p> <p>1. In the AOL Instant Messenger main window, select Edit → Settings → Enhanced IM → Video → Ir select <b>Dell Web Camera Filter</b> from the select webcam drop-down menu.</p> <p>2. Click the Finish button to save your changes</p> <p><b>NOTE:</b> Depending on the type of instant messaging software you are using, the procedure to enable De will be different. Please consult the help for the instant messaging software you are using and see the selecting webcam or something similar.</p> |
|--|--|

## Facial Recognition (FastAccess) problems

### Installation

| Common Symptoms                      | What You See   | Possible Solutions  |
|--------------------------------------|--|---|
| FastAccess software will not install | The FastAccess installer displays a dialog box with the message "This version cannot install on this computer -3"                          | 1 Ensure that the monitor USB cable is plugged into your computer. Monitor Webcam has been installed in the Windows Vista operating system. |
| FastAccess software will not install | The FastAccess installer displays a dialog box with the message "This version cannot install on this computer -2"                          | 1 This version of FastAccess will not install on a computer joined to a domain. Please install on a non-Domain computer.                    |
| FastAccess software will not install | The FastAccess installer displays a dialog box with the message "FastAccess cannot be installed on Systems earlier than Windows Vista x86" | 1 This version of FastAccess will only install on Windows Vista and Windows 2000 are not supported.   |

### Daily Use

| Common Symptoms  | What You See  | Possible Solutions  |
|--|---|---|
| Face Recognition is not possible and you must login manually         | Color Bars are displayed in the FastAccess Video window along with the text "Unable to process Biometric Data, please check camera" | 1 Ensure that the monitor USB cable is plugged into your computer. Monitor Webcam has been installed in the Windows Vista or Windows 7 operating system.<br>1 Login to the computer manually and close any applications that are using the webcam.<br>1 If you previously manually selected a webcam in the "Camera Configuration Console", ensure this webcam is installed. <b>not, select another webcam from the list. Selecting "First Available Webcam" will not enable FastAccess to connect to any available webcam.</b> |
| Face Recognition is not possible and you must login manually         | Color Bars are displayed in the FastAccess Video window along with the text "License key is invalid"                                | 1 Make sure the Dell Monitor's USB cable is plugged into the correct port. <b>Monitor Webcam is properly installed on this computer. FastAccess will not work if the Dell Monitor Webcam is not connected to the computer.</b>  |
| The wrong webcam is connected to FastAccess                          | You have a laptop with a built-in webcam and FastAccess is not using the desired webcam.  | 1 Open the "Configuration Console" and select the "Advanced" tab. Select the "Webcam Selection" link. <b>Select the desired webcam. Either reboot your computer or then re-enable FastAccess.</b>   |
| Face Recognition is unavailable                                      | FastAccess is missing from the Windows Vista login screen.  | 1 <b>FastAccess has been disabled. Open the "Configuration Console" and select the "Advanced" tab. Select the "Webcam Selection" link. Select the desired webcam. Either reboot your computer or then re-enable FastAccess.</b>   |
| Video applications such as Skype, IM and others can find the webcam. | You are unable to get active video to another application.  | 1 If FastAccess is enabled, open the video application's camera settings and select "FastAccess".<br>1 If FastAccess is disabled, open the video application's camera settings and select "Monitor Webcam" or another available webcam.   |

## Touch Screen problems

| Common Symptoms   | Possible Solutions  |
|---|---|
| Touch screen does not respond to touches                                    | 1 Make sure the USB cable is connected from the monitor to the computer.<br>1 Make sure the touch screen is connected to a USB port that provides enough power for it (some peripherals, such as external hard drives, do not provide sufficient power for some devices). Try connecting the touch screen to a different USB port on the computer.<br>1 Before changing any settings or drivers, try restarting the computer. |
| The cursor does not accurately follow your finger when you touch the screen | 1 This can occur if the touch screen needs calibrating. To fix the problem, see <a href="#">Calibrating the Touch Screen</a> .  |
| The cursor moves erratically  | 1 Make sure there is nothing blocking the optics of the touch screen. There are two sensors in the top corners of the screen that need unobstructed views across the surface of the glass to the bottom and side edges.<br>1 Clean the glass and edges of the screen. See <a href="#">Maintenance</a> for instructions.<br>1 If the above remedies do not work, run the diagnostic test that is explained below.              |





## Troubleshooting with Touch Screen Tools

## Calibrating the Touch Screen

With a clear desktop on the computer:

1. Run the Touch Screen Tools by clicking its icon in the system tray or Windows Control Panel.
2. Make sure the computer desktop is clear.
3. Click the [Calibrate] button on the Touch Screen Tools. The mouse pointer moves automatically to a position at the top left of the screen.
4. Touch and hold your finger (or stylus) on the screen at that position until the pointer moves.
5. The pointer moves to three further positions in sequence—top right, bottom right, bottom left—touch each point in turn until the pointer moves.

This completes the touch screen calibration procedure.

-  **NOTE:** When removing your finger, lift it straight off the screen, making sure you don't drag it across the screen.
-  **NOTE:** Test the calibration by moving the mouse pointer around the screen checking that it closely follows your finger.
-  **NOTE:** If the calibration is not satisfactory, you can re-calibrate.
-  **NOTE:** Make sure your finger is placed accurately at each calibration point.

## Diagnostic Test

This option on the Touch Screen Tools runs a diagnostic test on the touch screen and displays one of the following three messages:

| Result  | Meaning   | Action  |
|---|---|---|
| Pass.   | Touch screen is working normally.                 | 1 You can use the touch function now.   |
| Touch Screen is not connected, reconnect screen and try again. If problem persists call customer support. | There may be possible connection problems.        | 1 Re-check all cable connections on the monitor and computer test again.  |
| Please clean the screen and if problem persists call customer support.                                    | Screen may be dusty and cause improper detection. | 1 Using the cleaning cloth supplied, clean the screen and surround bezel gently taking care to avoid cameras located on the top of the screen. Re-run the diagnostic test again after cleaning. |

---

[Back to Contents Page](#)